

EA2813QY-T User's Guide

5V/2.4A Power Bank Solution

Description

This document supports the **EA2813QY-T** Evaluation Kit. This kit is a proven application-circuit design for the ACT2813QY-T charger with power path and single USB outputs. The EVK contains a single micro-USB input and USB output. It provides a 2.4A output. It is configured to charge a battery with 2.4A. The EVK operates with very high charge efficiency of 91% and discharge efficiency of 95% (Vbat=4.1V). This EVK demonstrates the ACT2813QY-T charger, but other ACT2813xxx options can be evaluated on this EVK by replacing the IC and any other necessary components. The following table shows the differences between these ICs.

PART NUMBER	OUTPUT	CHARGE CURRENT	BATTERY VOLTAGE	FLASHLIGHT /TH	PB TURN OFF BOOST	PACKAGE
ACT2813QY-T	5V/2.4A	2.4A	4.2V	TH	Yes	FCQFN 4x4-20
ACT2813QY-T0435	5V/2.4A	2.4A	4.35V	TH	Yes	FCQFN 4x4-20
ACT2813CQY-T	5V/2.4A	2.4A	4.2V	Flashlight	No	FCQFN 4x4-20
ACT2813CQY-T0435	5V/2.4A	2.4A	4.35V	Flashlight	No	FCQFN 4x4-20

Features

The EVK contains a high efficiency Buck and Boost DC/DC converter that operates either in CV (Constant Voltage) mode or CC(Constant Current) mode. The EVK provides up to 5V/2.1A output at 550 kHz switching frequency. It operates from VIN=4.5V to 5.5V to charge a 1S Li-Ion battery. Gerber files are available to minimize time-to-market for applications that want to use the EVK as an end product.

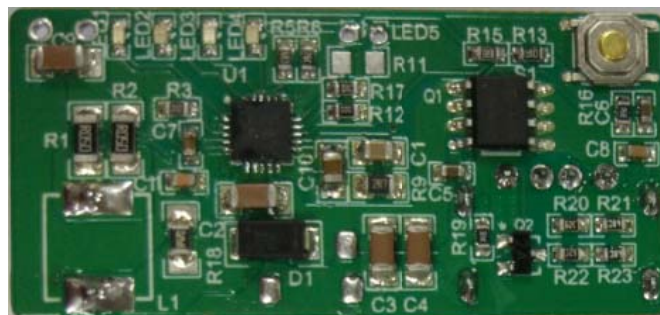

Figure 1 – EVK Picture - Top



Figure 2 – EVK Picture – Bottom

Setup

Required Equipment

EA2813QY-T EVK

Power supply – 5V @ 3A for full power operation

Oscilloscope – >100MHz

Loads –Electronic/resistive load with 3A minimum current capability.

Digital Multimeters (DMM)

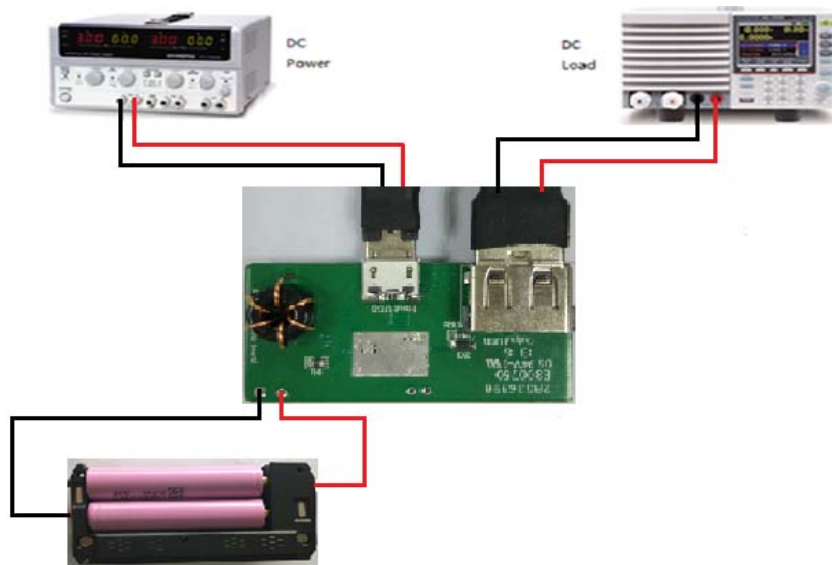

Figure 3 – EVK Setup

Hardware Setup

1. Connect a DC power supply to the input USB connector.
2. Connect the EVK output to an electronic load using the USB connector.
3. Connect battery across C9 terminals as shown in Figure 3. Pay close attention to the battery polarity.

Table1. Recommended Operating Conditions

Parameter	Description	Min	Typ	Max	Unit
VIN	All buck input voltages	4.5	5	5.5	V
IOUT	Maximum load current		2.4		A

EVK Operation

Boost Mode (Discharge Mode)

With the battery connected and a load connected, press the pushbutton to force the IC from the HIZ Mode to Discharge Mode. In Discharge Mode, the IC boosts the battery to a 5V output.

Note if no load is applied for 16s, the IC enters HIZ Mode due to light load cutoff. Press the pushbutton to exit HIZ mode.

Charge Operation

With the battery connected, apply 5V to the input USB connector. The IC automatically transitions from HIZ Mode to Charge Mode

PCB Layout

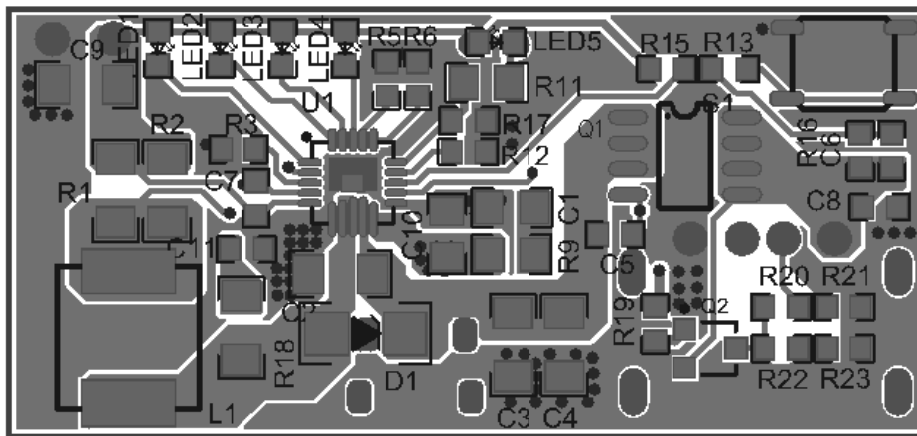

Top Layer

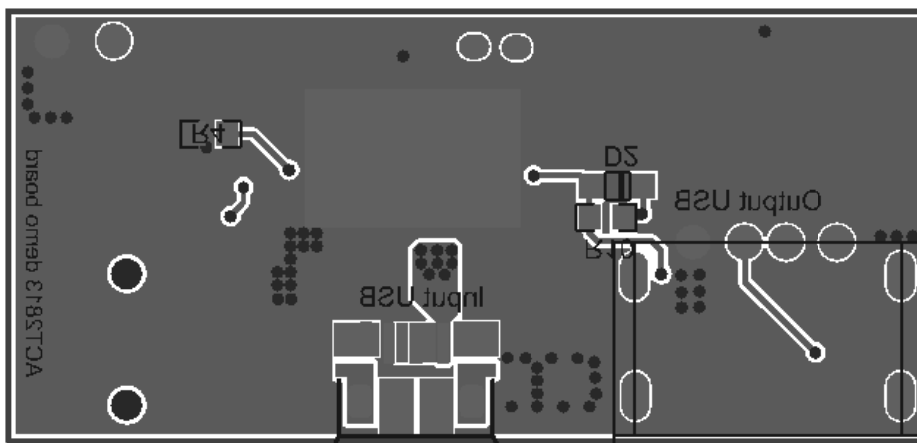

Bottom Layer

Test Results

Battery Charge Feature

Vbat (V)	0	1.0	2.0	2.4	2.5	2.8	2.9	3.4	3.8	4.0	4.21	4.22
Icharge (mA)	380	331	290	260	228	227	2381	2372	2367	2356	2235	0

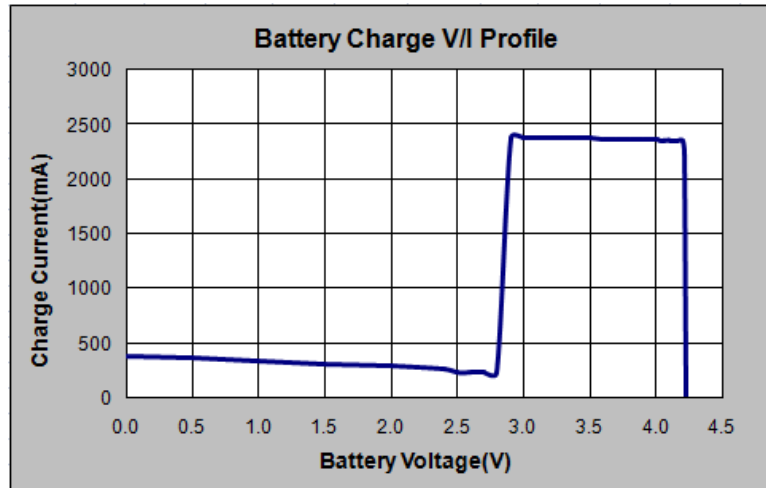

Charge Efficiency

(Vin=5V and charge current set at 2400mA)

Battery Voltage (V)	3.0	3.2	3.5	3.7	3.9	4.1
Efficiency (%)	89.8	90.1	90.6	91.1	91.1	91.3

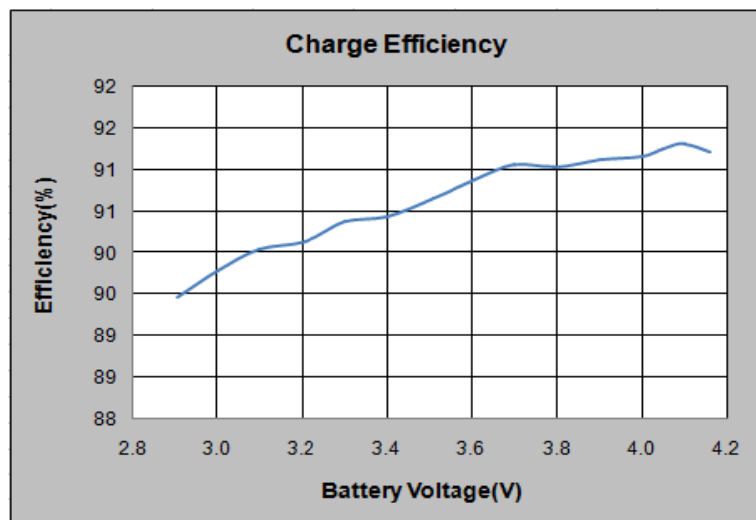

Boost Efficiency and Power Loss (Ta=25°C)

Vbat	Efficiency (%)					
	Io=100mA	Io=500mA	Io=1000mA	Io=1500mA	Io=2000mA	Io=2400mA
3.2V	81.3	92.5	92.7	90.9	88.7	86.2
3.7V	85.5	93.2	94.0	92.8	91.0	89.5
4.1V	88.1	94.0	95.1	94.4	93.0	91.8

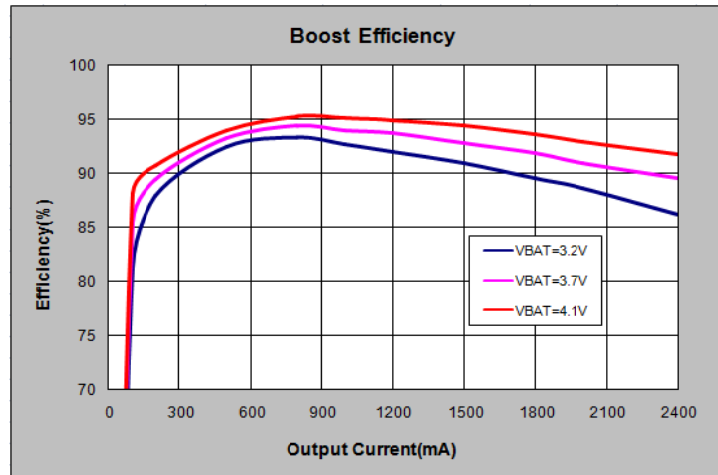

Vbat	Power Loss (W)					
	Io=100mA	Io=500mA	Io=1000mA	Io=1500mA	Io=2000mA	Io=2400mA
3.2V	0.12	0.21	0.39	0.75	1.29	1.93
3.7V	0.09	0.18	0.32	0.58	0.99	1.41
4.1V	0.07	0.16	0.26	0.45	0.76	1.08

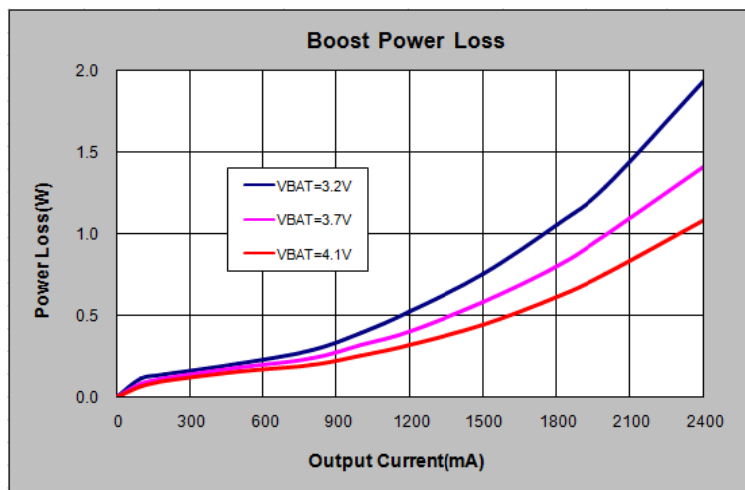

Boost Constant Current and Constant Voltage Regulation (Ta=25°C)

	Vbat=3.2V		Vbat=3.7V		Vbat=4.1V	
	Vout(V)	Iout(mA)	Vout (V)	Iout(mA)	Vout(V)	Iout(mA)
CC Load	5.05	0	5.05	0	5.05	0
	5.03	1000	5.03	1000	5.03	1000
	5.02	2000	5.01	2000	5.01	2000
	5.01	2400	5.01	2400	5	2400
	5.01	2600	5.01	2600	5	2600
CV Load	5	2636	5	2670	5	2696
	4.85	2643	4.85	2681	4.85	2696
	4.75	2650	4.75	2686	4.75	2705
	4.65	2653	4.6	2694	4.6	2707
	4.5	2658	4.5	2698	4.5	2714
	4.3	2668	4.3	2705	4.3	2720
	4.27	2673	4.27	2708	4.27	2726
	4.25	0	4.25	0	4.25	0

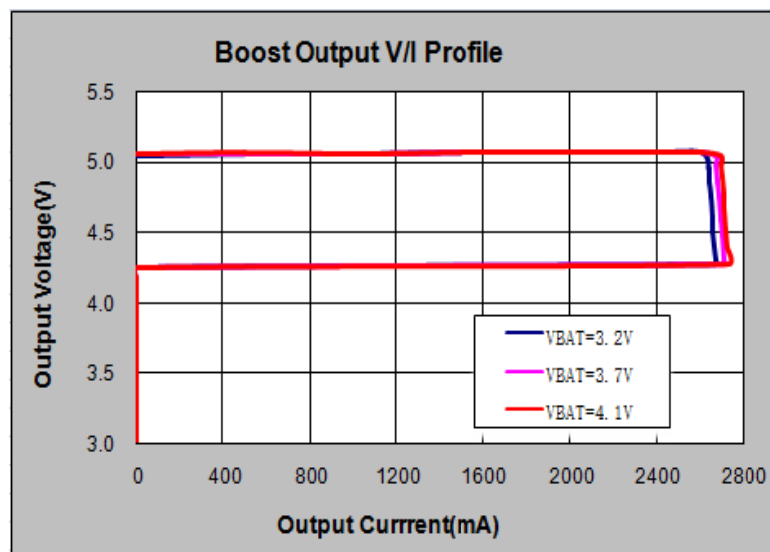
Battery Leakage Current in HZ Mode

Test Conditions	Battery Leakage (μA)	Power Loss (μW)
Vbat=2.8V	5.3	14.8
Vbat=3.2V	5.8	18.6
Vbat=3.7V	6.6	24.4
Vbat=4.1V	7.4	30.3

Ripple and Noise

Ripple & noise are measured by using 20MHz bandwidth limited oscilloscope.

Test Conditions	Output Ripple at 1A Load (mV)	Output Ripple at 2.4A Load (mV)
Vbat=3.2V	32	76
Vbat=3.7V	31	59
Vbat=4.1V	27	54

Load Dynamic Response Load Step(Vbat=3.7V)

CH1: output voltage CH4:output current

80mA-1000mA-80mA load step 1000mA-2400mA-1000mA load step

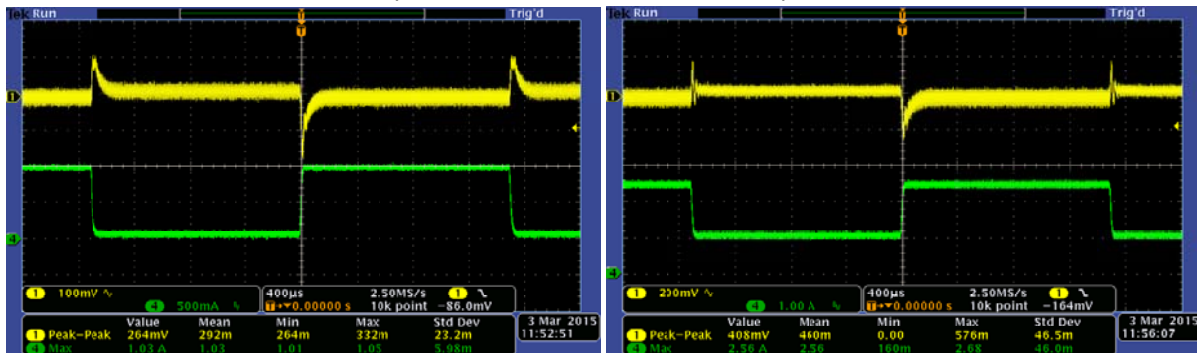

LED Indication

Conventional LED indication

PB time>30ms (HZ Mode)	LED1	LED2	LED3	LED4
VBAT<VLED1	Off	Off	Off	Off
VLED1≤VBAT<VLED2	On	Off	Off	Off
VLED2≤VBAT<VLED3	On	On	Off	Off
VLED3≤VBAT<VLED4	On	On	On	Off
VBAT≥VLED4	On	On	On	On

Charge Mode	LED1	LED2	LED3	LED4
VBAT<VLED1	Flash	Off	Off	Off
VLED1≤VBAT<VLED2	Flash	Off	Off	Off
VLED2≤VBAT<VLED3	On	Flash	Off	Off
VLED3≤VBAT≤VLED4	On	On	Flash	Off
VLED4≤VBAT≤EOC Mode	On	On	On	Flash
LED4≤VBAT(EOC Mode)	On	On	On	On

System Management

ACT2813/ACT2813B System Operation Flow Chart

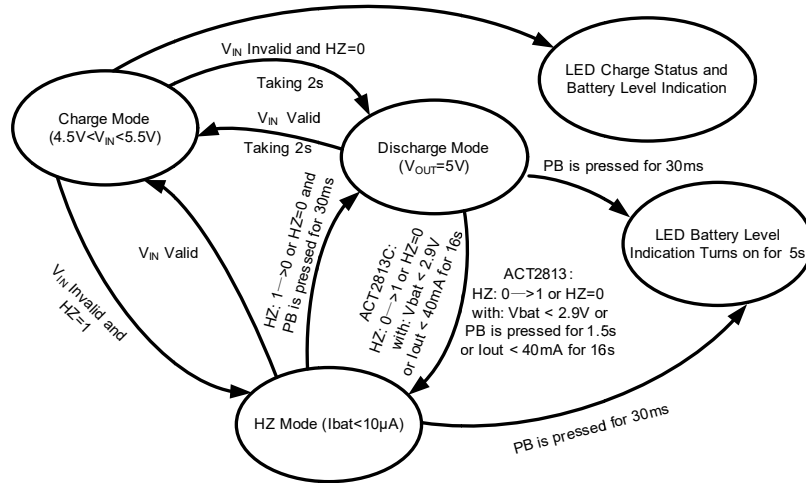
Key Components Temperature Test (T_a=40°C, burning for 2 hours)

Charge mode, 2.4A charge current

Vbat(V)	IC(°C)	Diode(°C)	Inductor(°C)	PCB(V)
3.2V	56.8	48.6	52.6	49.7
3.7V	59.0	50.1	52.3	51.5
4.1V	63.1	53.2	54.0	54.9

Boost mode, 2.4A output current

Vbat(V)	IC(°C)	Diode(°C)	Inductor(°C)	PCB(°C)
3.2	94.4	80.6	82.0	77.4
3.7	76.6	65.7	67.2	64.2
4.1	68.3	59.9	60.0	58.7

EMI Test

Vbat=4.1V, Output: 5V/2.4A Horizontal

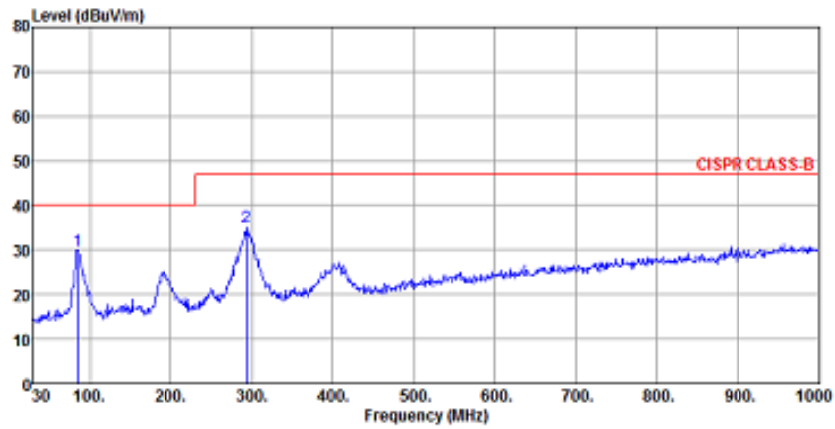

Site : chamber
 Condition : CISPR CLASS-B 3m VULB9160 HORIZONTAL
 EUT :
 Model Name : ACT2813 MS-018 #2
 Temp/Humi : 23 °C / 51 %
 Power Rating: BAT=4V
 Mode : DISCHARGE 2.4A
 Memo : WITH 1N4148

		ReadAntenna	Cable	Preamp	Limit	Over			
	Freq	Level	Loss	Factor	Level	Line	Limit	Remark	
	MHz	dBuV	dB/m	dB	dB	dBuV/m	dBuV/m	dB	
1	pp	85.29	19.83	8.89	1.09	0.00	29.81	40.00	-10.19 Peak
2		293.84	19.60	13.08	2.37	0.00	35.05	47.00	-11.95 Peak

Vbat=4.1V, Output: 5V/2.4A Vertical

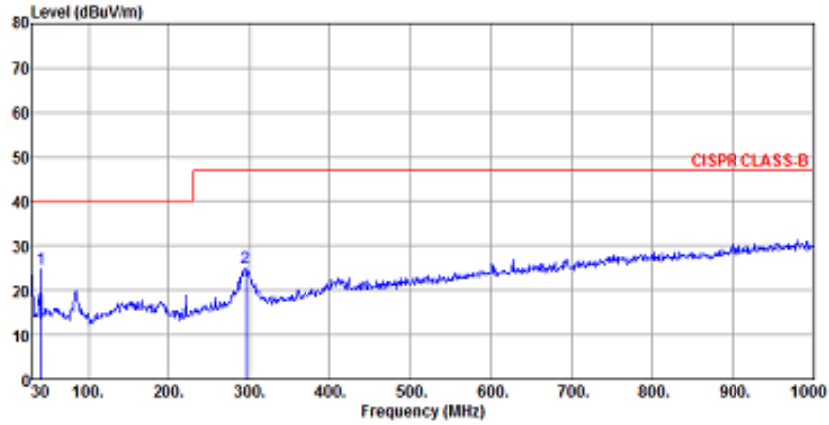

Site : chamber
 Condition : CISPR CLASS-B 3m VULB9160 VERTICAL
 EUT :
 Model Name : ACT2813 MS-018 #2
 Temp/Humi : 23 °C / 51 %
 Power Rating: BAT=4V
 Mode : DISCHARGE 2.4A
 Memo : WITH 1N4148

	ReadAntenna	Cable	Preamp	Limit	Over			
Freq	Level	Factor	Loss	Factor	Level	Line	Limit	Remark
MHz	dBuV	dB/m	dB	dB	dBuV/m	dBuV/m	dB	
1 pp	40.67	11.30	12.71	0.83	0.00	24.84	40.00	-15.16 Peak
2	294.81	9.59	13.11	2.40	0.00	25.10	47.00	-21.90 Peak

Schematic

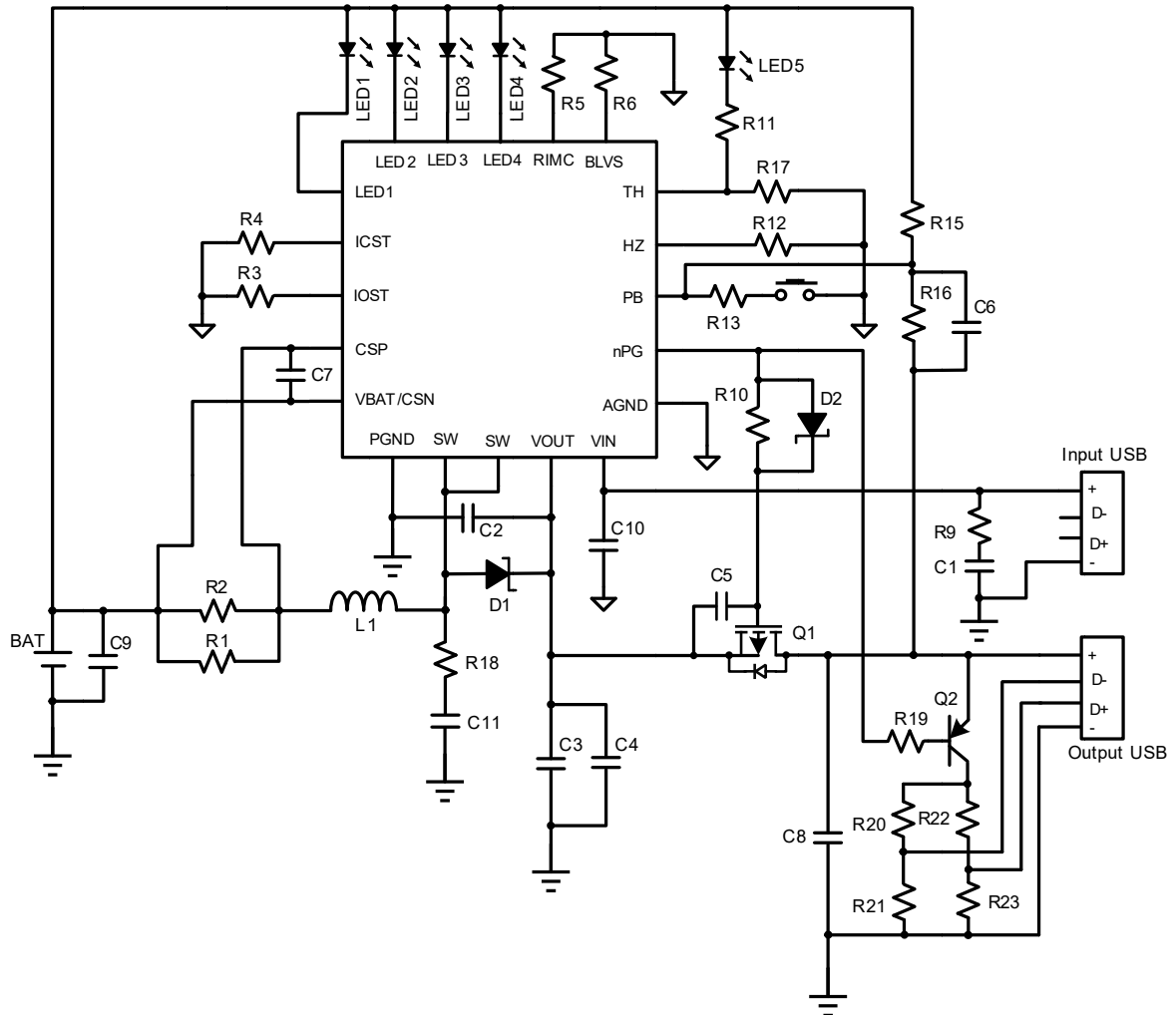

EA2813QY-T Bill of Materials

ITEM	REFERENCE	DESCRIPTION	QTY	MANUFACTURER
1	L1	Core, 6.5*3*3 Dip, 2.2uH, 6A, R _{dson} =5mΩ	1	
2	Q1	AO4453, R _{dson} =19mΩ at V _{GS} = - 4.5 V	1	AOS
3	Q2	MMBT3906	1	Vishay
4	D1	SBR3U20SA, 20V/3A Schottky	1	Diodes
5	D2	1N4148, V _f =0.7V, 75V Schottky	1	Vishay
6	C1	Ceramic capacitor, 4.7uF/10V, X7R, 0805	1	Murata/TDK
7	C2,C3,C4,C9	Ceramic capacitor, 22uF/10V, X7R, 1206	4	Murata/TDK
8	C5,C6	Ceramic capacitor, 2.2uF/10V, X7R, 0603	2	Murata/TDK
9	C7	Ceramic capacitor, 10nF/10V, X7R, 0603	1	Murata/TDK
10	C8	Ceramic capacitor, 0.1uF/10V, X7R, 0603	1	Murata/TDK
11	C10	Ceramic capacitor, 10uF/10V, X7R, 0805	1	Murata/TDK
12	C11	Ceramic capacitor, 4.7nF/10V, X7R, 0603	1	Murata/TDK
13	R1,R2	Chip Resistor, 50mΩ, 1/4W, 1%, 1206	2	Sart
14	R3,R10	Chip Resistor, 100kΩ, 1/10W, 1%, 0603	2	Murata/TDK
15	R4	Chip Resistor, 48kΩ, 1/10W, 1%, 0603	1	Murata/TDK
16	R5	Chip Resistor, 68kΩ, 1/10W, 5%, 0603	1	Murata/TDK
17	R6	Chip Resistor, 60.4kΩ, 1/10W, 1%, 0603	1	Murata/TDK
18	R9	Chip Resistor, 2.7Ω, 1/8W, 1%, 0805	1	Murata/TDK
19	R11	Chip Resistor, 51Ω, 1/8W, 1%, 0805	0	Murata/TDK
20	R12	Chip Resistor, 0Ω, 1/10W, 5%, 0603	1	Murata/TDK
21	R13	Chip Resistor, 100Ω, 1/10W, 1%, 0603	1	Murata/TDK
22	R15	Chip Resistor, 715kΩ, 1/10W, 5%, 0603	1	Murata/TDK
23	R16,R19	Chip Resistor, 200kΩ, 1/10W, 5%, 0603	2	Murata/TDK
24	R17	Chip Resistor, 10kΩ, 1/10W, 5%, 0603	1	Murata/TDK
25	R18	Chip Resistor, 0.47Ω, 1/4W, 1%, 1206	1	Murata/TDK
26	R20,R22	Chip Resistor, 43.2kΩ, 1/10W, 1%, 0603	2	Murata/TDK
27	R21,R23	Chip Resistor, 49.9kΩ, 1/10W, 1%, 0603	2	Murata/TDK
28	LED1,LED2 LED3,LED4	LED, 0603, Blue	4	LED Manu
29	LED5	Flashlight	0	LED Manu
30	PB	Push Button	1	
31	USB	10.2*14.6*7mm, 4P, DIP	1	
32	Micro-USB	MICRO USB 5P/F SMT B	1	
33	U1	IC, ACT2813QY-T	1	Active-Semi