

ACT4529EVK1 User's Guide

USB Type C Car Charger Solution

Description

This document describes the characteristic and operation of the Active Semi ACT4529EVK1 evaluation kit (EVK). It provides setup and operation instructions, schematic, layout, BOM, and test data. This EVK demonstrates the ACT4529YH-T1011. Other ACT4529YH-Txxx options can be evaluated on this EVK by replacing the IC and any other necessary components.

Features

The EVK is a complete, stand-alone USB-PD and QC2.0 car charger solution. It is built with an automotive car charger form factor to show performance in a real form factor application. The EVK contains the high efficiency ACT4925 step-down DC/DC converter that operates in either CV(Constant Output Voltage) mode or CC(Constant Output Voltage) mode.

The EVK features a USB Type C output connector with USB-PD, QC2.0, and USB Auto Detect decoding protocols. Decoding is implemented with an on-board FUSB302MPX USB Type-C controller and STM32F030F4P6 MCU. The EVK provides up to 3.0A output current at 125kHz switching frequency. It operates from $V_{in}=12V$ to 36V and provides an output voltage of 5.1V, 9.1V, or 12.1V depending on the load's requested voltage. It charges Samsung and BC1.2 charging protocols at full charge current. Gerber files are available to minimize time-to-market for applications that want to use the EVK as an end product.



Figure 1 – EVK Picture - Top

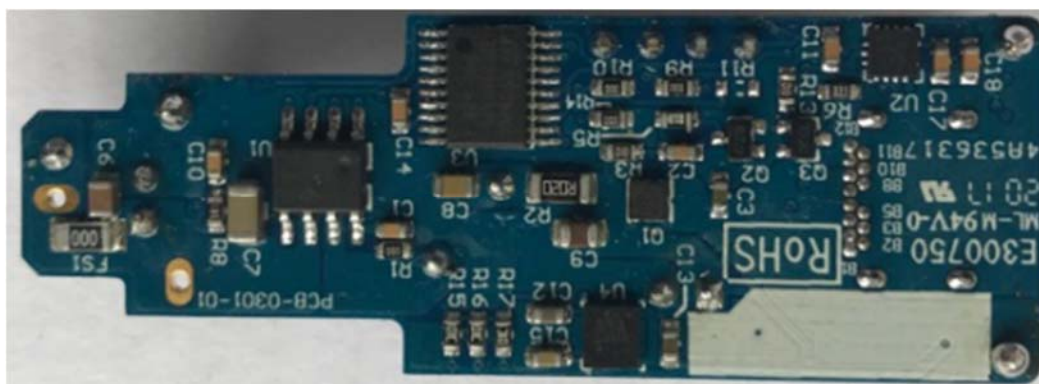

Figure 2 – EVK Picture - Bottom

Setup

Required Equipment

ACT4529EVK1 EVK

Power supply – 40V @ 4A for full power operation

Oscilloscope – >100MHz, >2 channels

Loads –Electronic/resistive load with 3.5A minimum current capability.

Digital Multimeters (DMM)

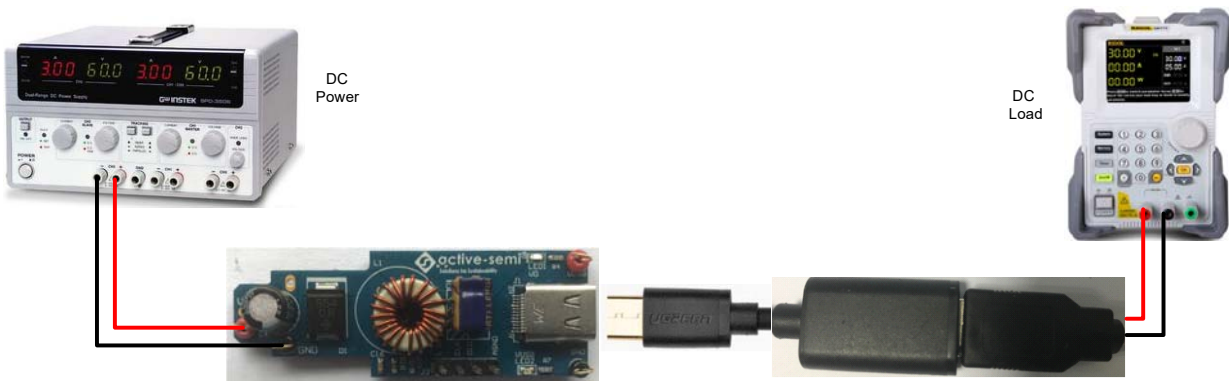

Figure 3 – EVK Setup

Hardware Setup

1. Connect a DC Power to the VIN and GND jumpers on the left side of the EVK.
2. Using a USB Type C connector, connect the EVK output to an electronic load.
3. Do not connecting anything to J2. J2 is a programming header.

Recommended Operating Conditions

Table 1. Recommended Operating Conditions

Parameter	Description	Min	Typ	Max	Unit
VIN	All buck input voltages	10	12	36	V
IOUT	Maximum load current		3.0		A

EVK Operation

Turn on

Apply the 12V input voltage. The portable load can be connected before or after the input voltage is applied. LED1 turn on to indicate that the buck converter is operational. LED2 turns on to indicate that the IC has properly communicated with output load and is delivering power to the output connector.

PCB Layout

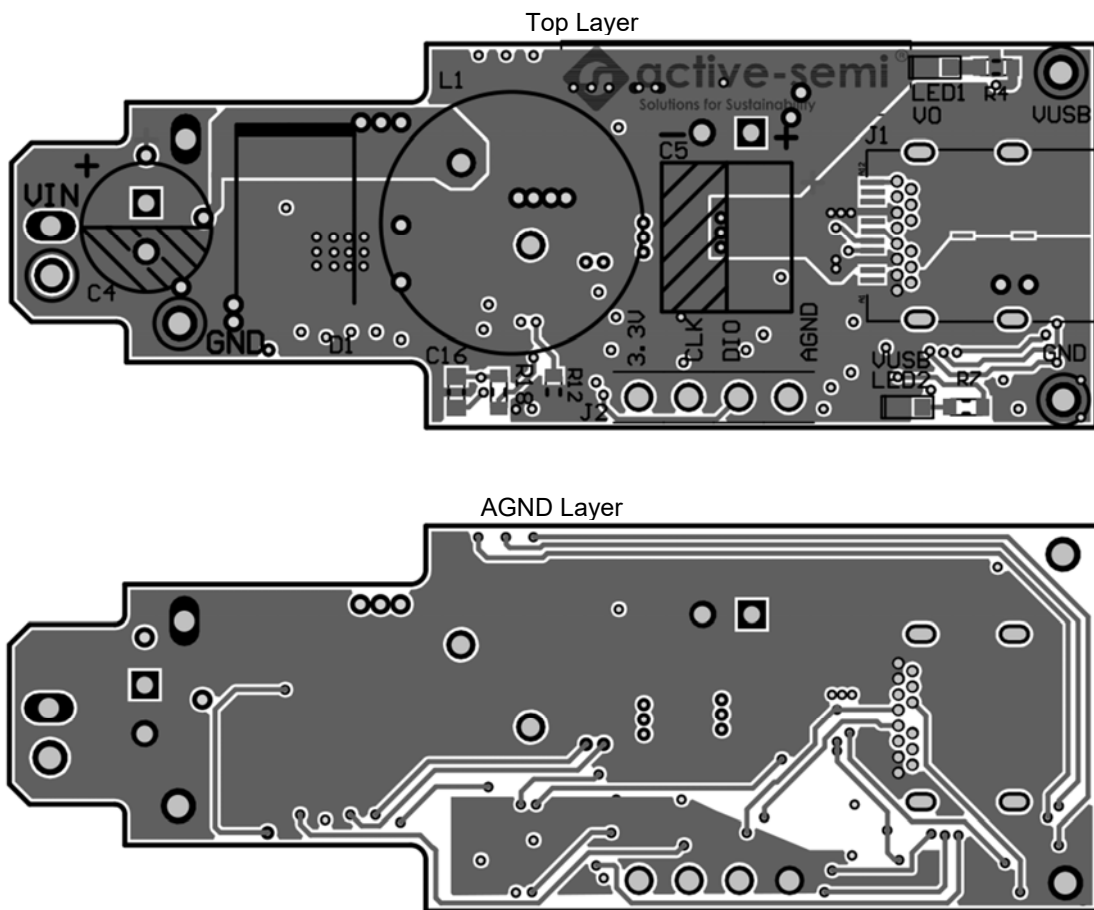

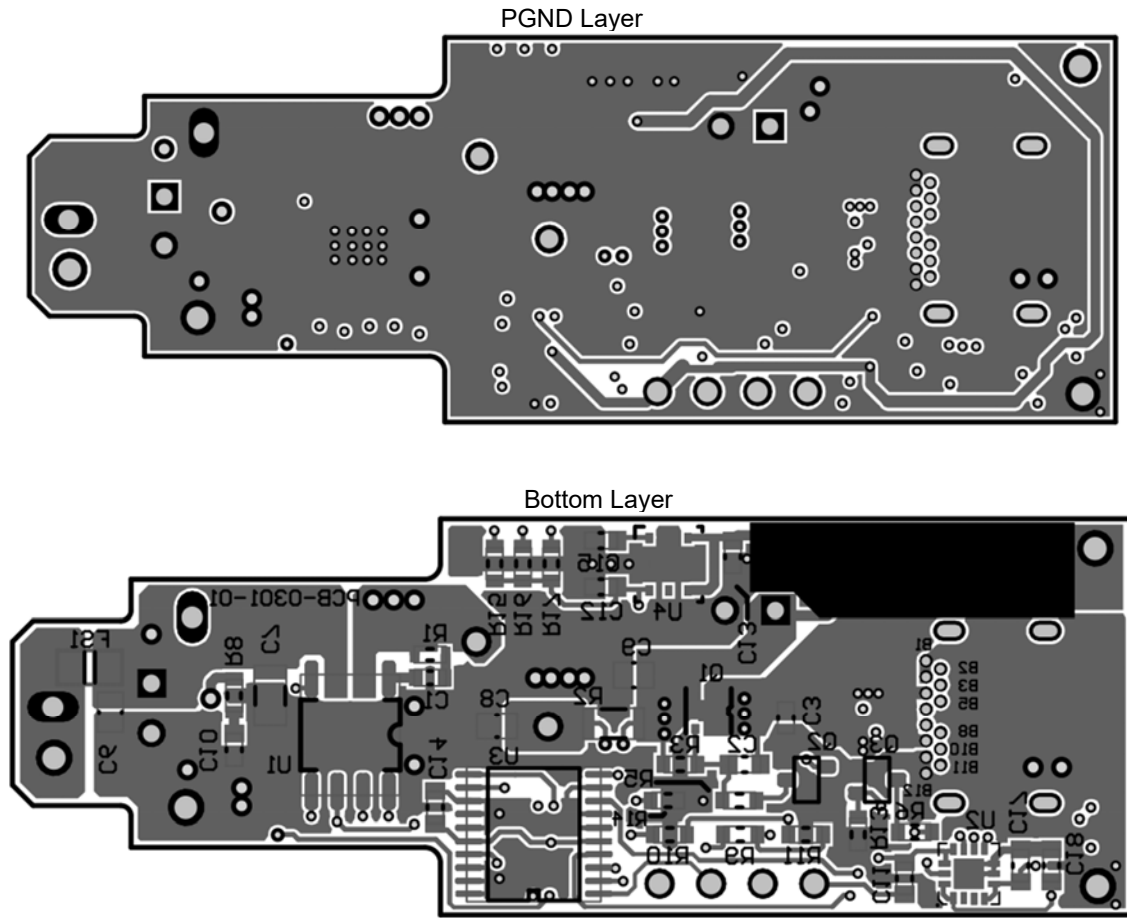

Test Results

Output Regulation

Float the PDC pin Vout is 5.1V, Connect the PDC pin to GND Vout is 9.1V, Connect the PDC pin to 3.3V(connect to C14) Vout is 12.1V. Set DC electronic load to CC mode. Increase output current from 0A to 3A and measure the output voltage on C3 capacitor.

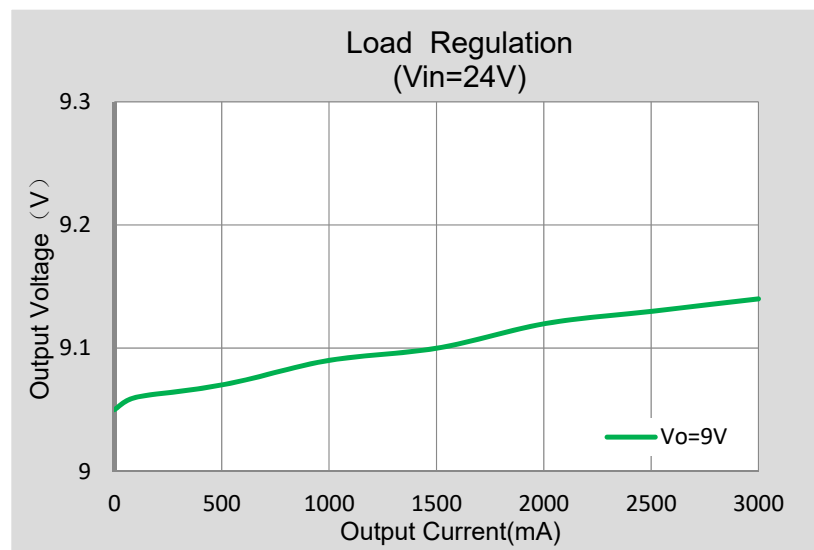
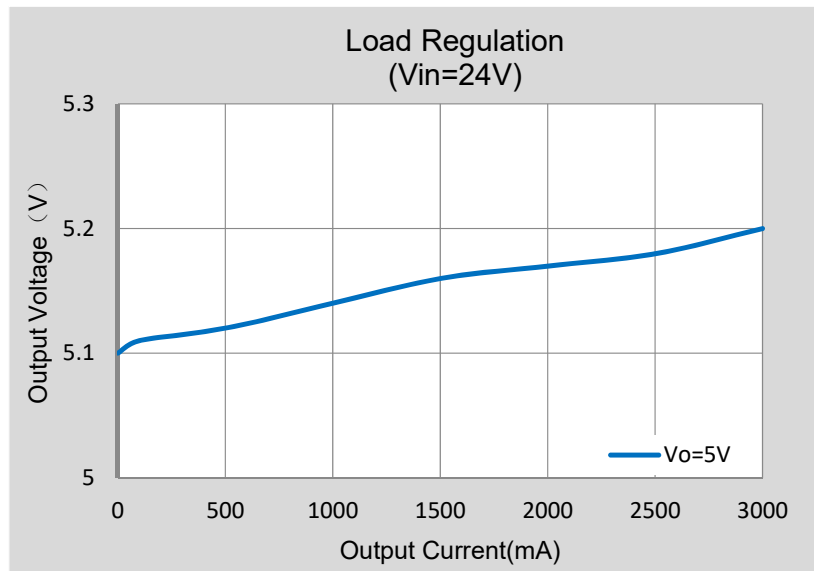

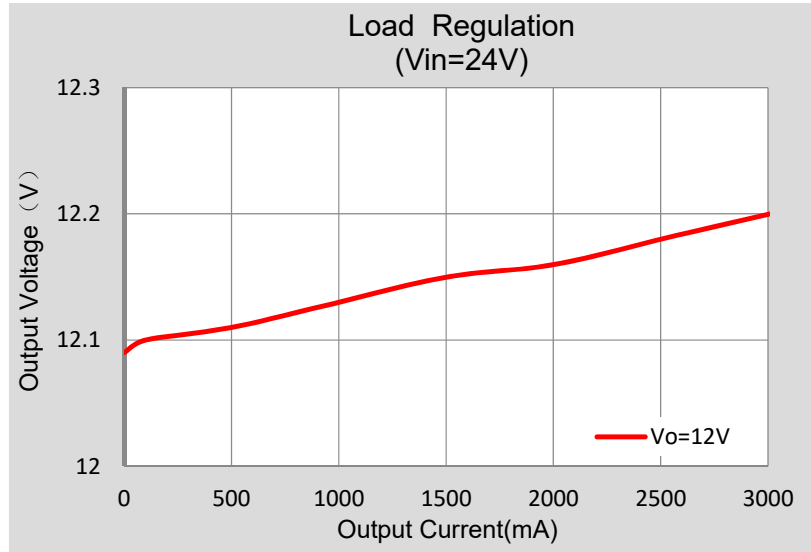

Efficiency ($T_a=25^{\circ}C$)

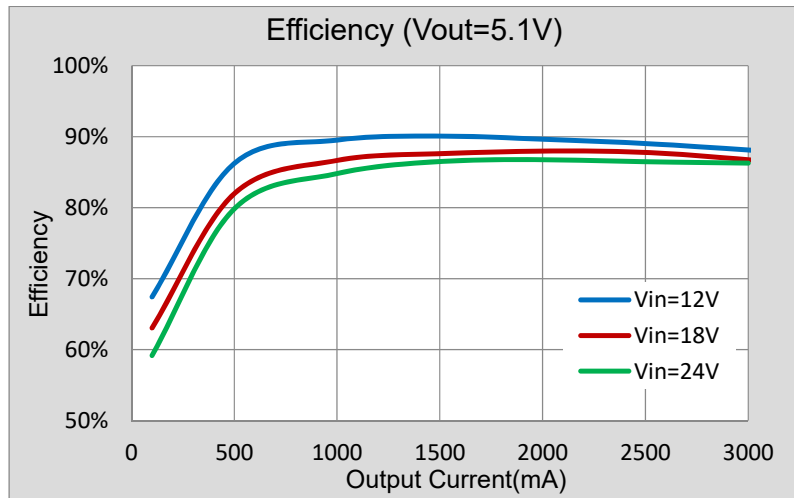

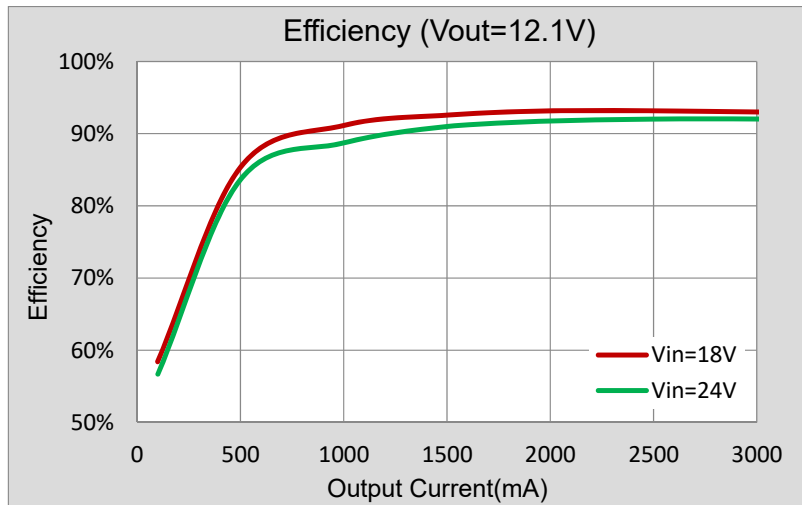
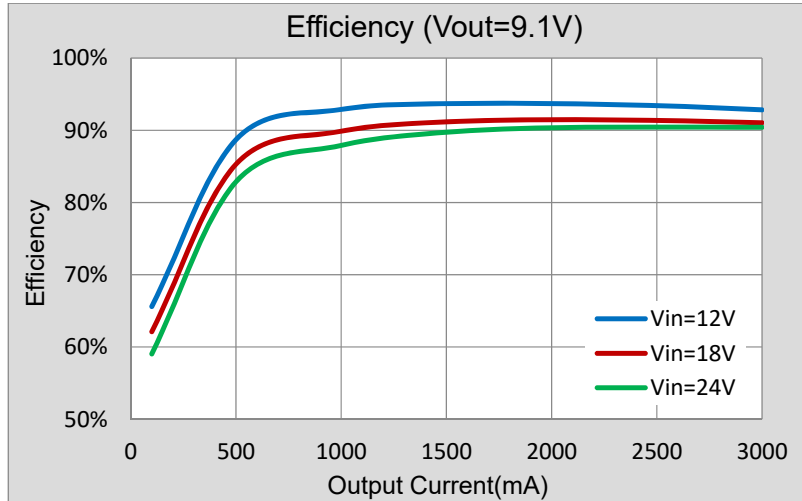

Power Loss

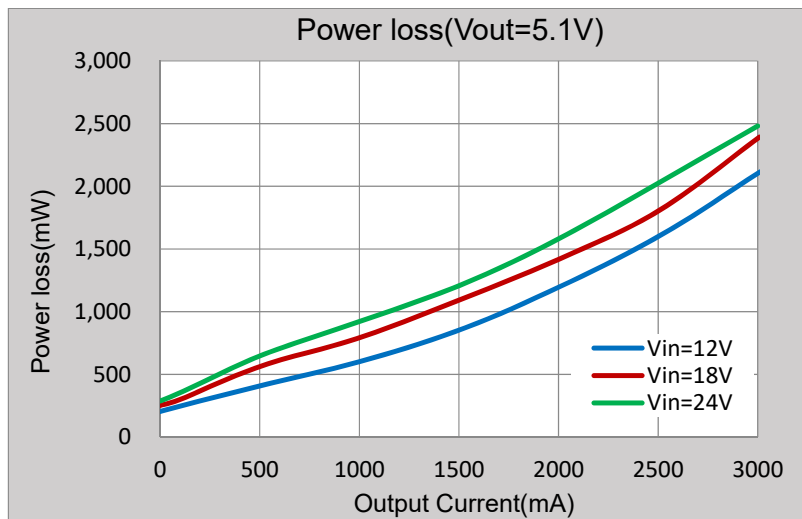

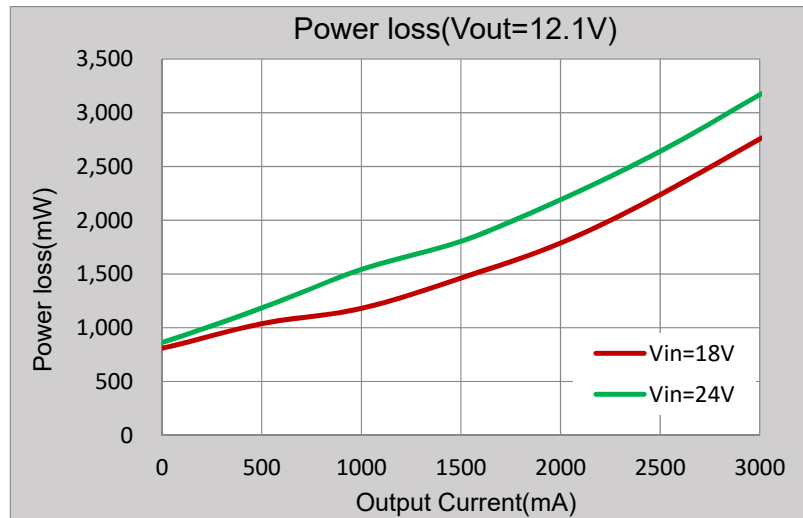
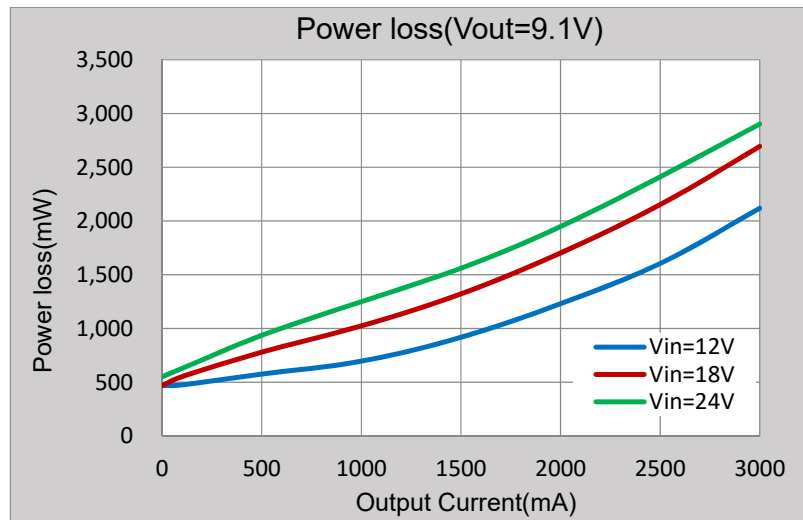

Output Constant Current and Constant Voltage (Ta=25°C)

Set DC load to CC mode, increase output current from 0A to the maximum load current and measure the voltage on the C3 capacitor. Then set DC electronic load to CV mode, decrease output voltage from maximum load voltage to 0V and measure the output current and the output voltage on the C3 capacitor.

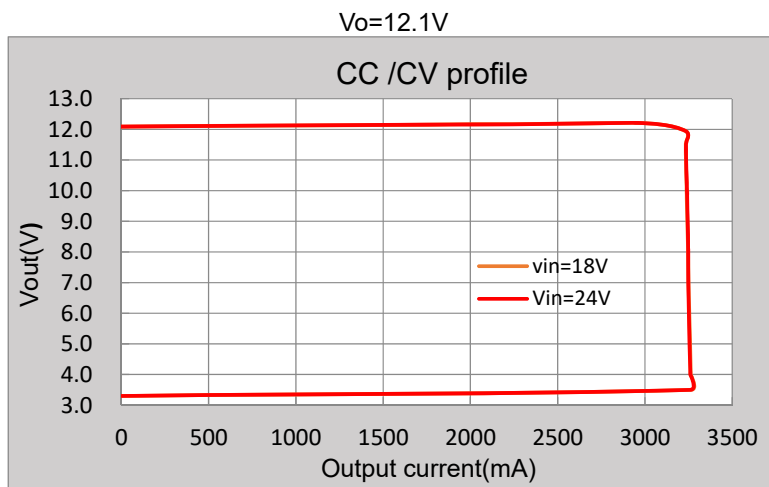
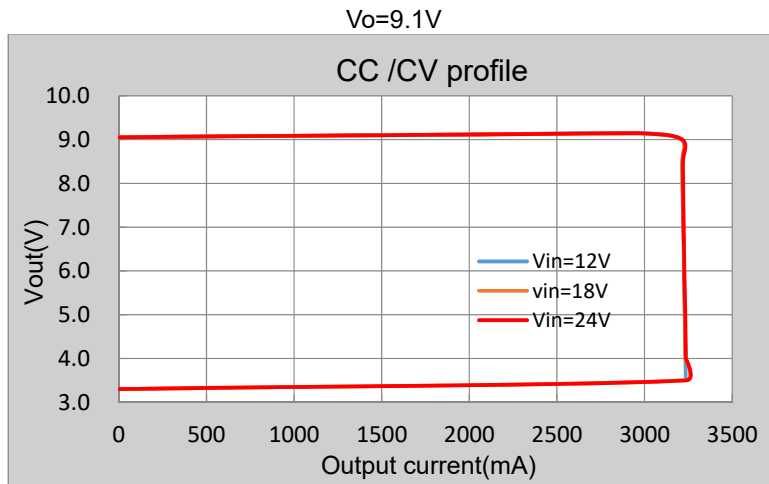
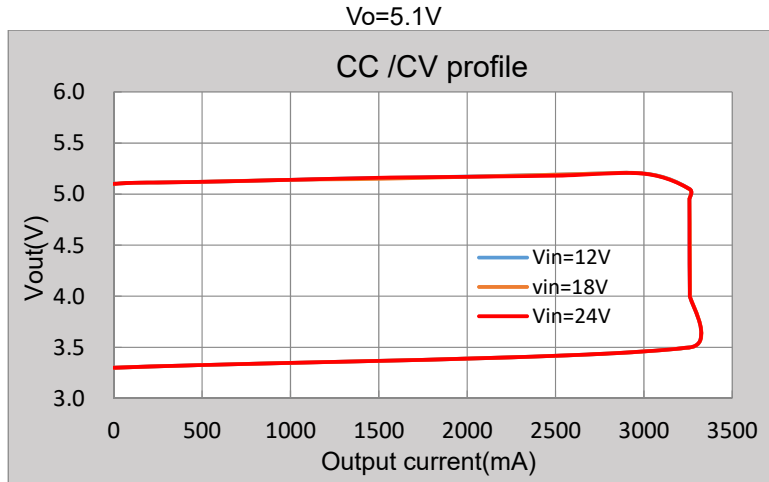

Standby Input Current

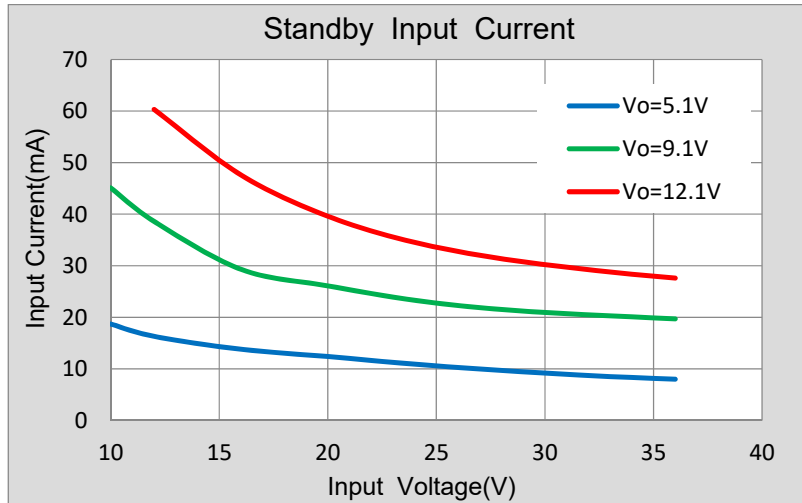

Current Limit vs. input voltage

Set DC electronic load to CV mode to measure the output current.

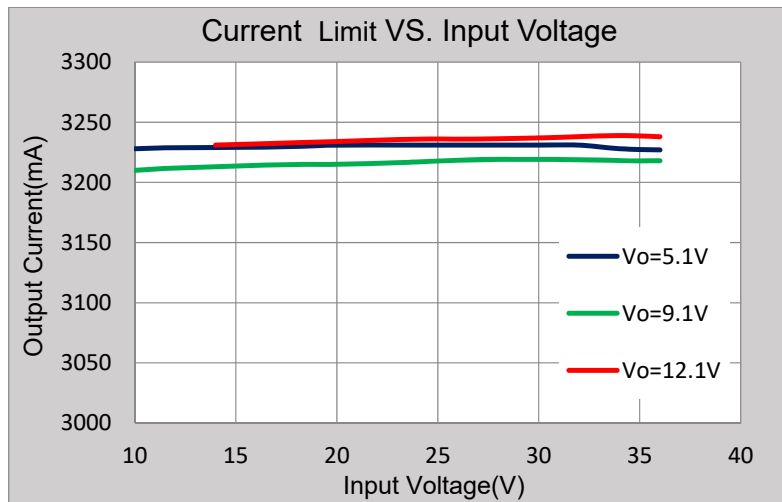

Ripple and Noise

CH1 : Vout

Vo=5V

Vin=12V 1A output load

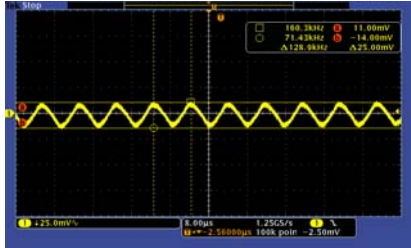

Vin=12V 3A output load

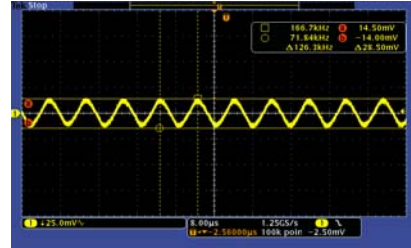

Vin=24V 1A output load

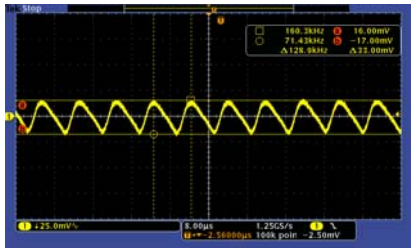

Vin=24V 3A output load

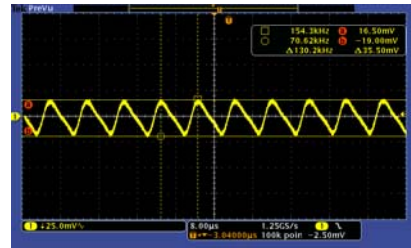

Vout=9V

Vin=12V 1A output load

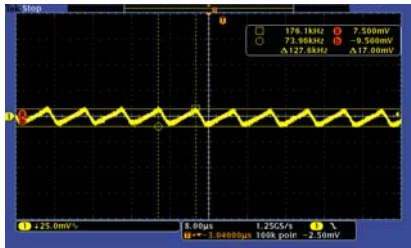

Vin=12V 3A output load

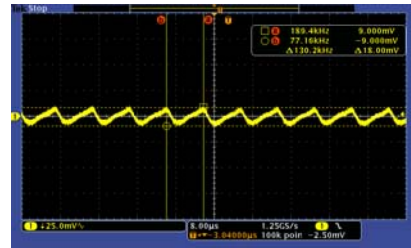

Vin=24V 1A output load

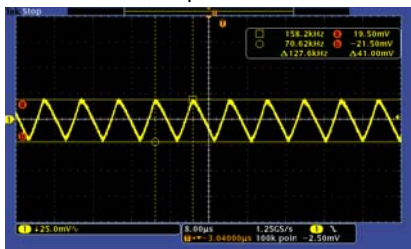

Vin=24V 3A output load

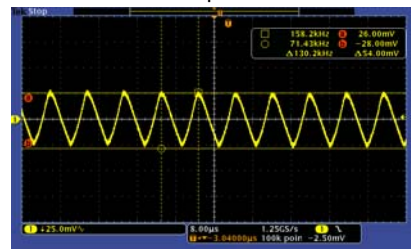

Vo=12V

Vin=18V 1A output load

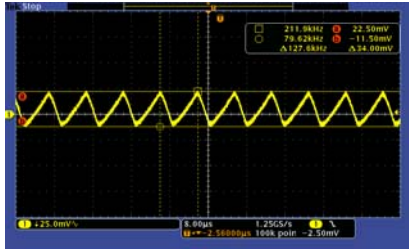

Vin=18V 3A output load

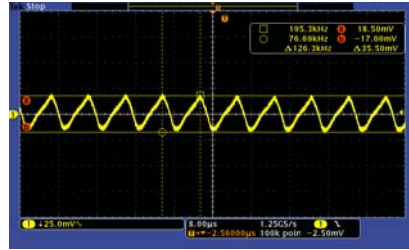

Vin=24V 1A output load

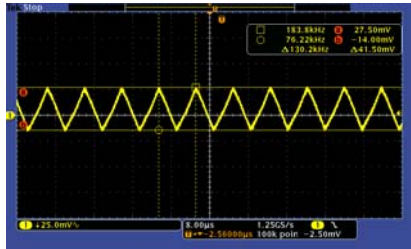

Vin=24V 3A output load

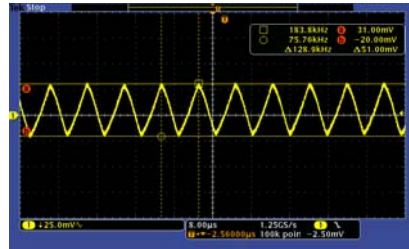

Ripple & noise are measured by using 100MHz bandwidth limited oscilloscope.

Test Conditions		Output Ripple	
Vout (V)	Vin (V)	Io=1000mA	Io=3000mA
5.1	12	25.0mV	28.5mV
	24	33.0mV	35.5mV
9.1	12	17.0mV	18.0mV
	24	41.0mV	54.0mV
12.1	18	34.0mV	35.5mV
	24	41.5mV	51.0mV

Load Transient Response

CH1:Vout CH4:lout

Vin=12V load step 80mA-1A -80mA

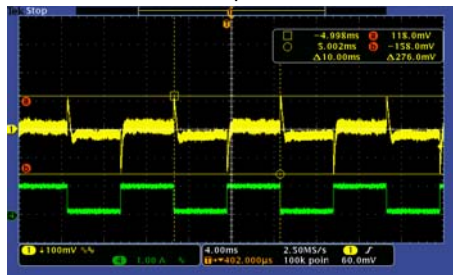

Vin=12V load step 1A-3A-1A

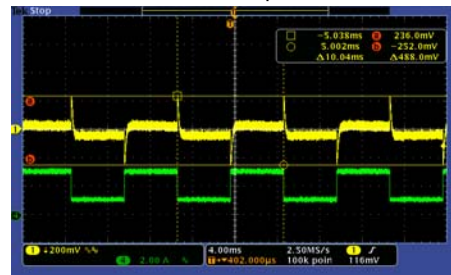

Vin=24V load step 80mA-1A-80mA

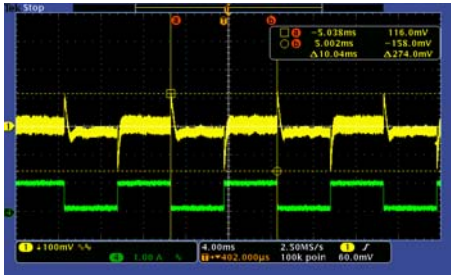

Vin=24V load step 1A-3A-1A

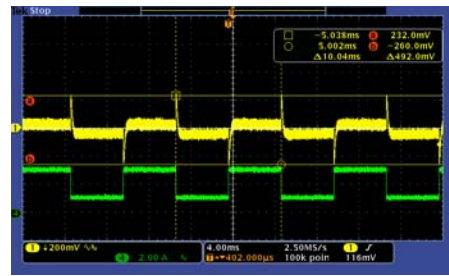

Line Transient Response(Vin change from 12V to 40V, 1V/us)

CH1:Vout CH3:Vin

Iout=1A

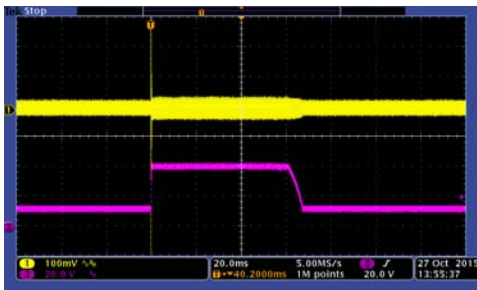

Iout=3A

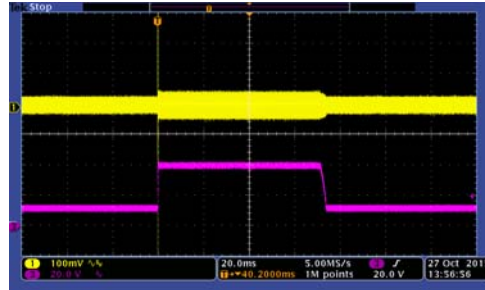

Key Component Temperature Test
 (Ta=27deg C, after 1 hour steady state operation)

Vout	Test condition (Iout=3A)	Component temperature(°C)					
		Temp in CLA	PCB	Output Cap	IC	Diode	Inductor
5V	12V	75	90	89	96	105	103
	24V	81	96	95	103	115	112
9V	12V	85	97	94	102	108	106
	24V	95	111	108	122	129	122
12V	12V	83	105	104	114	114	116
	24V	89	112	110	125	129	125



Schematics

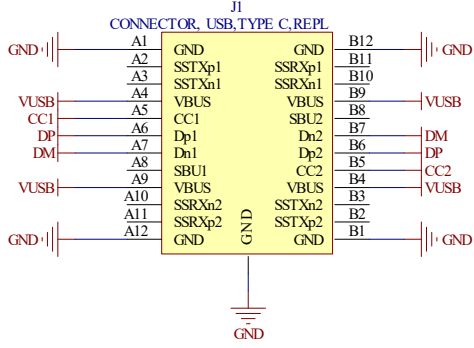
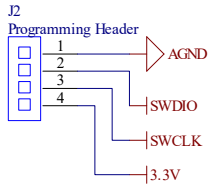
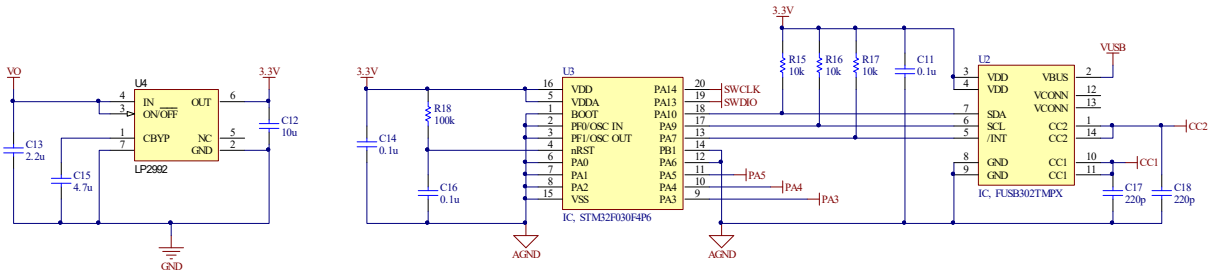
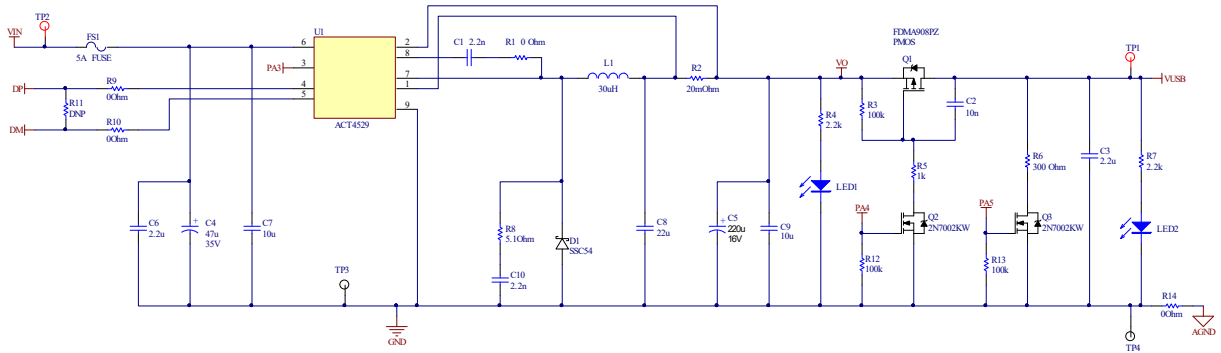

Bill of Materials

#	Designator	QTY	Description	Package	MFR	Manufacturer PN
1	C1, C10	2	Cap, Ceramic, 2.2nF, 25V, 10%, X5R	0603	Standard	
2	C2	1	Cap, Ceramic, 10nF, 16V, 10%, X5R	0603	Standard	
3	C3, C13	2	Cap, Ceramic, 2.2uF, 16V, 10%, X5R	0603	Standard	
4	C4	1	Cap, Electro, 47uF, 35V, 20%	6.3*7*2.5mm	SAMWHA	A1V476M6L07KVR
5	C5	1	Cap, Electro, 220uF, 16V, 10%	6.3*7mm	HUAKAI	SHK5227K0160607LLHT
6	C6	1	Cap, Ceramic, 2.2uF, 35V, 10%, X5R	0805	Standard	
7	C7	1	Cap, Ceramic, 10uF, 35V, 10%, X5R	1206	Standard	
8	C8	1	Cap, Ceramic, 22uF, 16V, 10%, X5R	0805	Standard	
9	C9	1	Cap, Ceramic, 10uF, 16V, 10%, X5R	0805	Standard	
10	C11, C14, C16	3	Cap, Ceramic, 0.1uF, 10V, 10%, X5R	0603	Standard	
11	C12	1	Cap, Ceramic, 10uF, 6.3V, 10%, X5R	0603	Standard	
12	C15	1	Cap, Ceramic, 4.7uF, 6.3V, 10%, X5R	0603	Standard	
13	C17, C18	2	Cap, Ceramic, 220pF, 10V, 10%, X5R	0603	Standard	
14	D1	1	Diode, Schottky, 40V, 5A	SMC	Standard	SSC54
15	FS1	1	Fuse, 5A	1206	Littlefuse	1206SFS300F/32
16	J1	1	Connector, USB, Type C, Recept, Horizontal THT & SMT	CON,U3S, TYPE-C,	Wurth	632723300011
17	J2	1	Header, Unshrouded , 2.54mm, Male, 4P		Wurth	61300411121
18	L1	1	Ind, Torroid, 30uH, 4.5A, 35mohm ESA31-00088F	6.5*13.2mm	E&E Mag- netics	831-03915F
19	LED1, LED2	2	LED, Green	0603	Wurth	150060VS75000
20	Q1	1	MOSFET, P-FET, 12V, 12.5mohm	MicroFET2X2	FairChild	FDMA908PZ
21	Q2, Q3	2	MOSFET, N-FET, 60V, 310mA	SOT323	Standard	2N7002KW
22	R1	1	Res, 0Ohm	0603	Standard	
23	R2	1	Res, 20mOhm, 1/4W, 1%	1206	Standard	
24	R3, R12, R13, R18	4	Res, 100k, 1/16W, 5%	0603	Standard	
25	R4, R7	2	Res, 2.2k, 1/16W, 5%	0603	Standard	
26	R5	1	Res, 1k, 1/16W, 5%	0603	Standard	
27	R6	1	Res, 300Ohm, 1/16W, 5%	0603	Standard	
28	R8	1	Res, 5.1Ohm, 1/16W, 5%	0603	Standard	
29	R9, R10, R14	3	Res, 0Ohm	0603	Standard	
30	R11	0	Res, 100Ohm	0603	Standard	
31	R15, R16, R17	3	Res, 10k, 1/16W, 5%	0603	Standard	
32	TP1, TP2	2	TEST POINT PC MINI .040"D RED	tpt,keystone-5000	Keystone Electronics	
33	TP3, TP4	2	TEST POINT PC MINI .040"D BLACK	tpt,keystone-5001	Keystone Electronics	
34	U1	1	IC, ACT4529, Buck with QC2.0, USB Auto-Detect, USB-PD	SO8-EP	Active-Semi	ACT4529YH-T1011
35	U2	1	IC, FUSB302TMPX, Programmable USB Type-C Controller w/PD	MLP-14	FairChild	FUSB302TMPX
36	U3	1	IC, STM32F030F4P6, MCU	TSSOP-20	ST	STM32F030F4P6
37	U4	1	IC, LDO, 250mA	WSON-6	Standard	LP2992AILDY-3.3/NOPB

38	-	1	PCB, PCB-0301-01		Standard	PCB-0301-01
39	-	1	Firmware		FairChild	FUSB302_Release_3p3p4_STM32F03x_CLA_DEMO_5-3_9-3_12-3_36W_Rp-3A_noVDMs_Active-Semi_20APR2017.bin