

**High Performance Car Charger with EMI Solution**

## FEATURES

- Wide input voltage range from 10V to 24V
- 5% output voltage accuracy
- No load standby input current 5mA
- 7.5% constant current accuracy
- Thermal shutdown protection
- Cycle-by-cycle current limit
- Cord compensation
- Over current protection with frequency fold back

## SPECIFICATION

DESCRIPTION	CONDITION	MIN	TYP	MAX	UNITS
Input Voltage		10		24	V
Switching Frequency			110		kHz
No-load Standby Input current	Vin=12V no Load		5		mA
	Vin=24V no Load		4		mA
Output Voltage		4.75	5	5.25	V
Output Current				1000	mA
Ripple Voltage	Vin=12V Io=1A		46		mVpp
Efficiency at full load	Vin=12V Io=1A		87.9		%
<b>ENVIRONMENTAL</b>					
ESD	Contact		4		kV
	Through air		8		kV
Ambient Temperature	Free convection	0		50	°C

**TABLE OF CONTENTS**

1. Demo Board Photo .....	3
2. Schematics .....	3
3. PCB Layout .....	3
4. Bill of Materials .....	4
5. Functional Test .....	5
5.1. Output Regulation .....	5
5.2. Efficiency .....	5
5.3. Constant Current and Constant Voltage .....	6
5.4. Power Loss .....	7
5.5. Standby Power Loss .....	7
5.6. Switching Frequency, Ripple and Noise .....	8
5.7. Key Components Temperature Test .....	8
6. EMC TEST .....	9
6.1. Radiated EMI Test .....	7
6.2. ESD Test .....	10

### 1. DEMO BOARD PHOTO

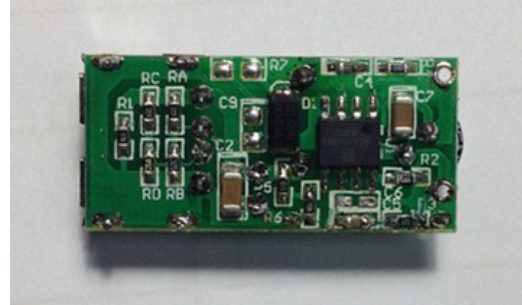
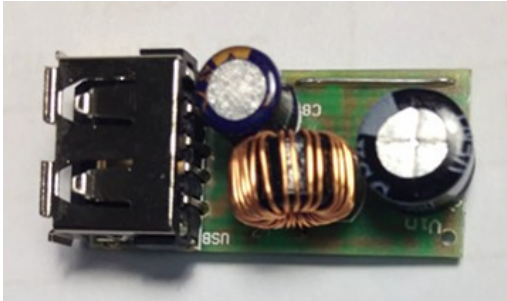

### 2. SCHEMATICS

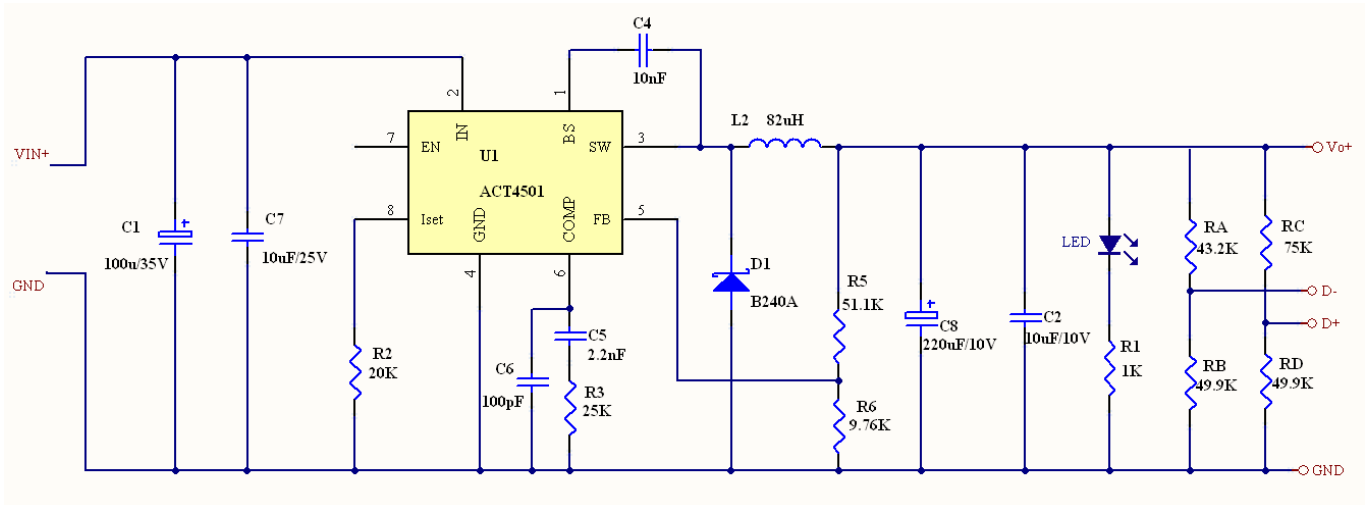

### 3. PCB LAYOUT

Bottom layer

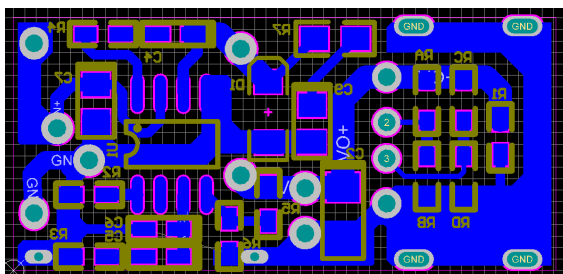

Top overlay

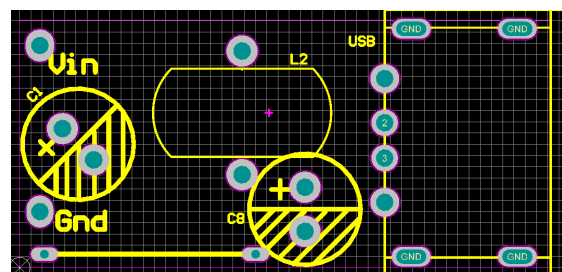

## 4. BILL OF MATERIALS

Item	Reference	Description	QTY	Manufacturer
1	L1	Choke Coil, ring core:8*4*5mm,Pi=0.35mm,L=82uH, dip	1	Haining Electronic-Magnetics
2	D1	Schottky Diode, B240A,2A/40V, SMA	1	Diodes
3	C1	Capacitor,Electrolytic,100uF/35V,Φ7x8mm,Dip	1	KSC
4	C2	Ceramic capacitor,10uF/16V,X7R,0805	1	Murata/TDK
5	C4	Ceramic capacitor, 10nF/25V, X7R, 0603	1	Murata/TDK
6	C5	Ceramic capacitor, 2200pF/25V, X7R, 0603	1	Murata/TDK
7	C6	Ceramic capacitor, 100pF/25V, X7R, 0603	1	Murata/TDK
8	C7	Ceramic capacitor, 10uF/25V, X7R, 0805	1	Murata/TDK
9	C8	Ceramic Electrolytic, 220F/10V, Φ6.3x7mm,Dip	1	Murata/TDK
10	C9	open		
11	R1	Chip Resistor, 1K Ω , 1/16W, 5%, 0603	1	Murata/TDK
12	R2	Chip Resistor, 20K Ω , 1/16W, 1%, 0603	1	Murata/TDK
13	R3	Chip Resistor, 25K Ω , 1/16W, 5%, 0603	1	Murata/TDK
14	R4	Chip Resistor, 0 Ω , 1/16W, 5%, 0603	1	Murata/TDK
15	R5	Chip Resistor, 51.1K Ω , 1/16W, 1%, 0603	1	Murata/TDK
16	R6	Chip Resistor, 9.76K Ω , 1/16W ,1%, 0603	1	Murata/TDK
17	R7	open		
18	R8	Chip Resistor, 5K Ω , 1/16W, 5%,0805	1	Murata/TDK
19	RB/RD	Chip Resistor, 49.9K Ω , 1/16W, 1%,0603	2	Murata/TDK
20	RA	Chip Resistor, 43.2K Ω , 1/16W, 1%,0603	1	Murata/TDK
21	RC	Chip Resistor, 75K Ω , 1/16W, 1%,0603	1	Murata/TDK
22	U1	IC, ACT4501 SOP-8	1	Active semi
23	USB	15mm*10mm*8mm	1	USB Manu

## 5. FUNCTIONAL TEST

### 5.1. Output Regulation

Voltage	Output Voltage at Max. load	Output Voltage at Min. load	Load regulation	Iload(max)
Vin=24V	5.08	4.97	-2.2%	1.2A
Vin=12V	5.09	4.98	-2.2%	

### 5.2. Efficiency

Iout	Efficiency (%)						
	Io=0mA	Io=100mA	Io=200mA	Io=300mA	Io=500mA	Io=750mA	Io=1000mA
Vin=24V	0.00	76.41	83.50	85.15	85.86	85.44	84.62
Vin=12V	0.00	84.11	89.09	90.03	90.14	89.15	87.94

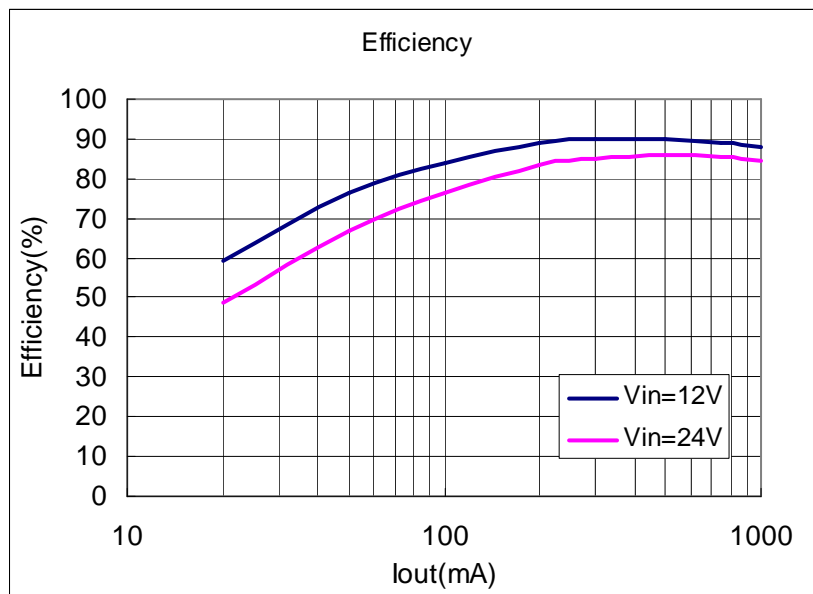

### 5.3. Constant Current and Constant Voltage

	Vin=12V Vout	Vin=12V Iout (mA)	Vin=16V Vout	Vin=16V Iout (mA)	Vin=24V Vout	Vin=24V Iout (mA)
<b>CC load</b>	5	0	5	0	5	0
	5	200	5	200	5	200
	5	400	5	400	5	400
	5	600	5	600	5	600
	5	800	5	800	5	800
	5	1000	5	1000	5	1000
	5	1270	5	1240	5	1200
<b>CV load</b>	4.9	1206	4.9	1290	4.9	1328
	4.75	1219	4.75	1291	4.75	1327
	4.7	1224	4.7	1292	4.7	1327
	4.5	1270	4.5	1293	4.5	1326
	4	1274	4	1295	4	1326
	3.5	1278	3.5	1297	3.5	1322
	3	1282	3	1301	3	1318
	2.5	1286	2.5	1302	2.5	1315
	2	1290	2	1306	2	1319
	1	1106	1	1187	1	1356
	0	1293	0	1313	0	1344

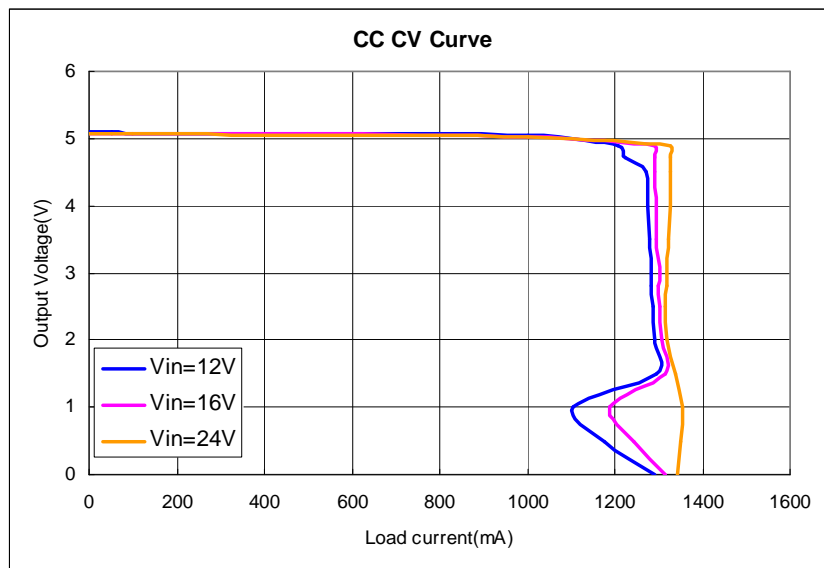

## 5.4. Power Loss

VIN	Power Loss(W)						
	I <sub>o</sub> =0mA	I <sub>o</sub> =100mA	I <sub>o</sub> =200mA	I <sub>o</sub> =300mA	I <sub>o</sub> =500mA	I <sub>o</sub> =750mA	I <sub>o</sub> =1000mA
Vin=24V	0.082	0.157	0.201	0.265	0.417	0.645	0.915
Vin=12V	0.056	0.096	0.124	0.169	0.277	0.461	0.691

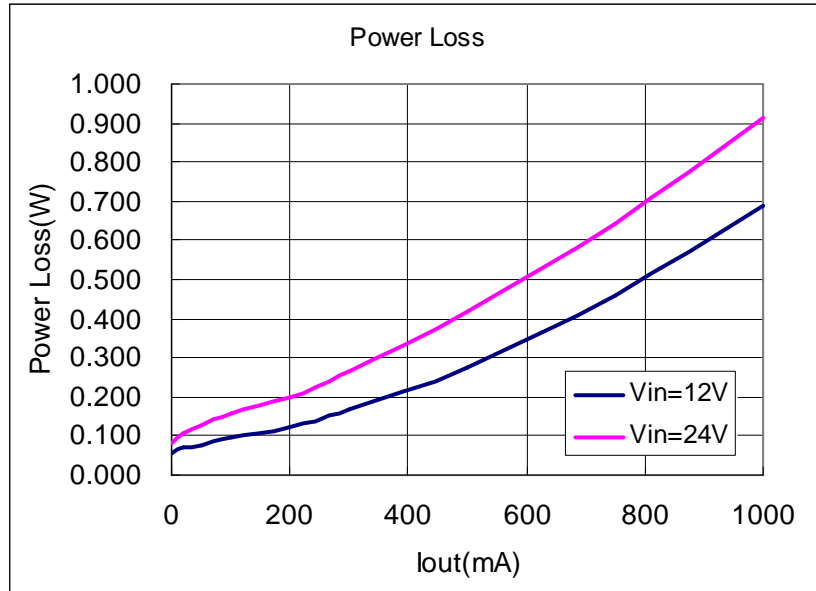

## 5.5. Standby Power Loss

Test Conditions	I <sub>in</sub> at No Load	Power Loss at No Load	
Vin=24V	4mA	92mW	Max Load: 1A No Load: 0A
Vin=12V	5mA	70mW	

## 5.6. Switching Frequency, Ripple and Noise

Ripple & noise are measured by using 20MHz bandwidth limited oscilloscope.

Test Conditions	Max load (mV)	Mini Load(mV)	
Vin=24V	50	25	Max Load: 1A Mini Load: 0mA
Vin=12V	46	20	

Vin=12V Io=1A

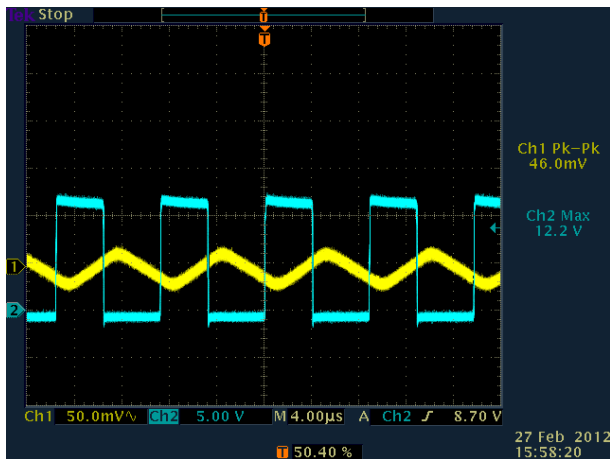

Vin=24V Io=1A

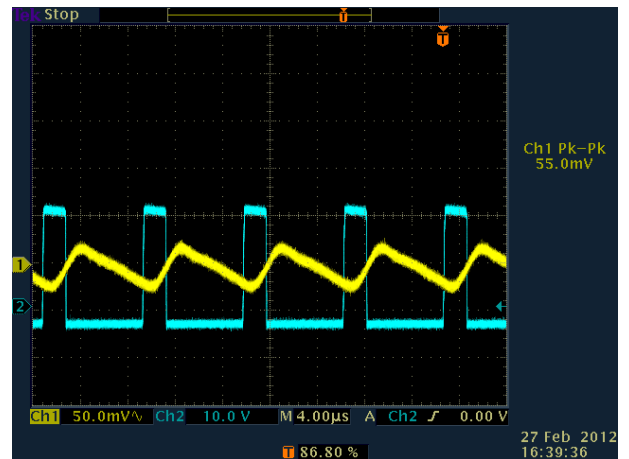

## 5.7. Dynamic Response

Vin=12V load step from 80mA-1A-80mA

Vin=24V load step from 80mA-1A-80mA

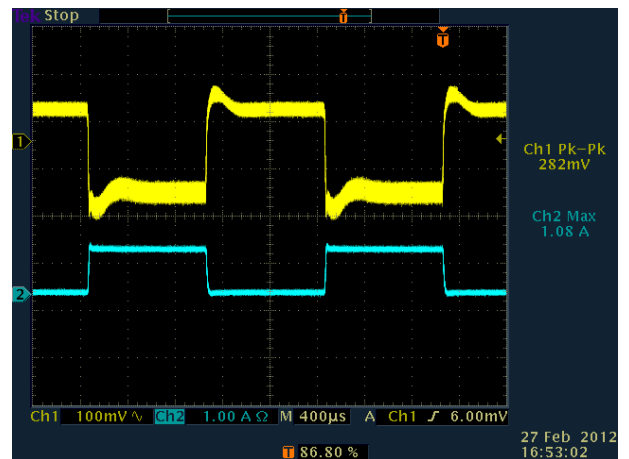
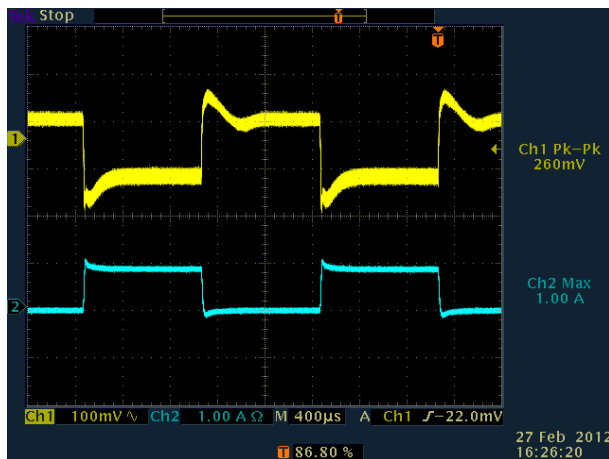

## 5.8. Temperature Test

Test condition: Ambient Temp: 55 °C; full load Io=1000mA

Test on IC ,Burning for 2 hours

Test Conditions	Vin=12V	Vin=24V
IC Top (°C)	97.2°C	109.5°C



## 6. EMC TES

### 6.1. Radiated EMI Test

Vin=12V Io=1A Horizontal



**BV ADT (Shanghai) Corporation 诚硕科技(上海)有限公司**

www.bureauveritas.com 2F, Building C, No. 1618, Yishan Rd., 201103, Shanghai, China

**A D T**

中国上海市宜山路 1618 号 C 栋 2F Tel:+86-21-64659091 Fax:+86-21-64659092

Brand / Model : DC90EX JC SINGLE DEMO #2,  
 Remark : DC12V  
 Tested by : Kevin Jiang

Location: ADT-SH 9x6x6 Chamber. Date: 2012-2-22 Time: 15:53 Approved by:  
 Temperature (C): 20.0 Humidity (%): 50 Polarity: **Horizontal**

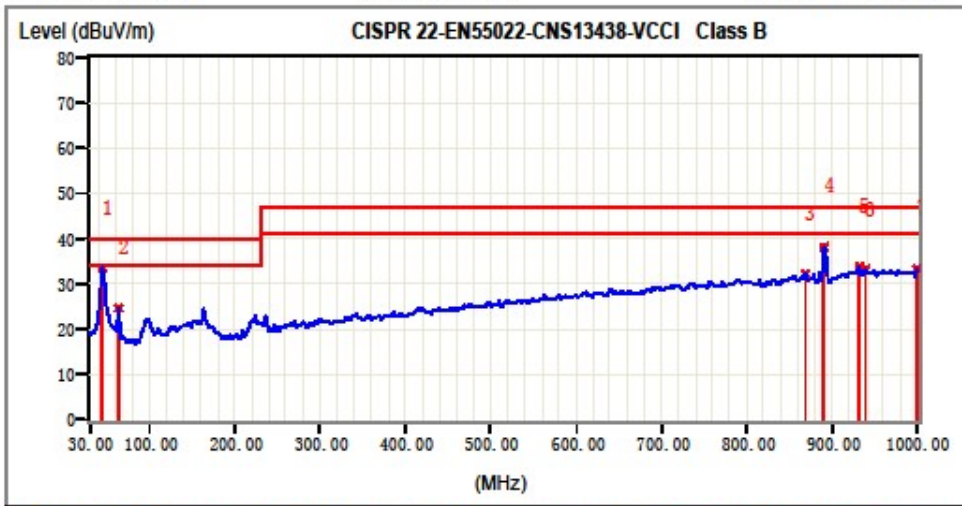

This data is for evaluation purposes only. It cannot be used for EMC approvals unless it contains the approved signature.  
 If you have any questions regarding the test data, you can write your comments to [service@mail.adt.com.tw](mailto:service@mail.adt.com.tw) V7.5.14

No.	Frequency MHz	Factor dB	Reading dBuV/m	Emission dBuV/m	Limit dBuV/m	Margin dB	Tower / Table cm deg	
* 1	44.55	15.41	18.14	33.55	40.00	-6.45	-	-
2	63.95	13.90	10.74	24.64	40.00	-15.36	200	0
3	809.05	26.16	6.17	32.32	47.00	-14.68	-	-
4	890.87	26.09	12.07	38.16	47.00	-8.84	-	-
5	932.10	27.31	6.48	33.79	47.00	-13.21	-	-
6	939.37	27.36	5.83	33.18	47.00	-13.82	-	-
7	1000.00	27.37	5.95	33.32	47.00	-13.68	-	-

Vin=12V Io=1A Vertical



**BV ADT (Shanghai) Corporation 诚硕科技(上海)有限公司**

www.bureauveritas.com 21, Building C, No. 1618, Yishan Rd., 201103, Shanghai, China

中国上海市宜山路 1618 号 C 栋 21F Tel:+86-21-64659091 Fax:+86-21-64659092

**A D T**  
 Brand / Model : DC90EX JC SINGLE DEMO #2,  
 Remark : DC12V  
 Tested by : Kevin Jiang

Location: ADT-SH 9x6x6 Chamber. Date: 2012-2-22 Time: 15:50 Approved by:  
 Temperature (C): 20.0 Humidity (%): 50 Polarity: Vertical

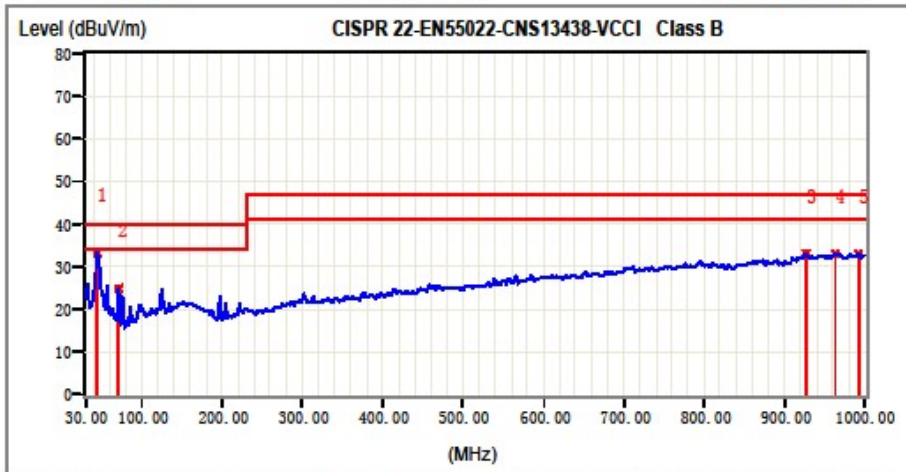

This data is for evaluation purposes only. It cannot be used for EMC approvals unless it contains the approved signature.  
 If you have any questions regarding the test data, you can write your comments to [service@mail.adt.com.tw](mailto:service@mail.adt.com.tw) V7.5.14

No.	Frequency MHz	Factor dB	Reading dBuV/m	Emission dBuV/m	Limit dBuV/m	Margin dB	Tower / Table cm deg	
* 1	44.55	15.41	17.81	33.22	40.00	-6.78	-	-
2	71.22	12.61	12.26	24.87	40.00	-15.13	100	0
3	927.25	27.28	5.85	33.13	47.00	-13.87	-	-
4	983.62	27.37	5.67	33.05	47.00	-13.95	-	-
5	992.73	27.36	5.59	32.95	47.00	-14.05	-	-

## 6.2. ESD Test

Test Condition	Vin=24V Io=1A	Vin=12V Io=1A
4KV contact	30 times pass	30 times pass
8KV air	30 times pass	30 times pass